

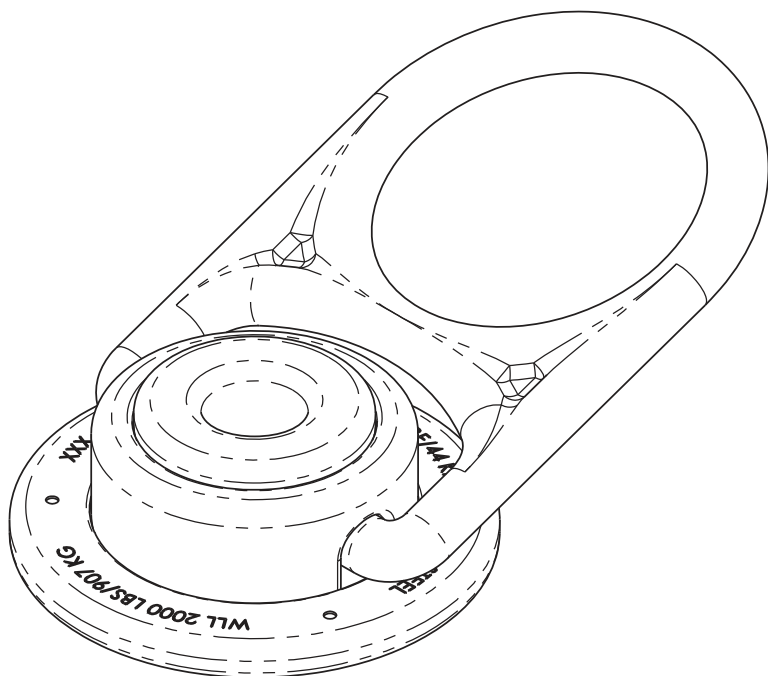

PIGEON MOUNTAIN

PMI®

INDUSTRIES



OPERATION AND INSTRUCTION MANUAL

Swivel Anchor Model: HD26248



IMPORTANT!!!

ALL PERSONS USING THIS EQUIPMENT MUST READ AND UNDERSTAND ALL INSTRUCTIONS. FAILURE TO DO SO MAY RESULT IN SERIOUS INJURY OR DEATH. USERS SHOULD BE FAMILIAR WITH PERTINENT REGULATIONS GOVERNING THIS EQUIPMENT. ALL INDIVIDUALS WHO USE THIS PRODUCT MUST BE PROPERLY INSTRUCTED ON HOW TO USE THIS DEVICE.

Read This Instruction Manual Carefully Before Using This Equipment.

User Instructions must always be available to the user and are not to be removed except by the user of this equipment. For proper use, see supervisor, User Instructions, or contact the manufacturer.



Compliant fall protection and emergency rescue systems help prevent serious injury during fall arrest. Users and purchasers of this equipment must read and understand the User Instructions provided for correct use and care of this product. All users of this equipment must understand the instructions, operation, limitations and consequences of improper use of this equipment and be properly trained prior to use per OSHA 29 CFR 1910.66 and 1926.503 or applicable local standards. **Misuse or failure to follow warnings and instructions may result in serious personal injury or death.**

PURPOSE

The HD26248 is an anchorage connector designed to function as an interface between the anchorage and a fall protection, work positioning, rope access, or rescue system for the purpose of coupling the system to the anchorage. Any references to "anchorage connector" in this manual include, and apply to, the HD26248.

USE INSTRUCTIONS

1. A user must be of sound mind and body to properly and safely use this equipment in normal and emergency situations. Users must have a physician ensure they are clear of any medical conditions that may affect the proper and safe use of this equipment in normal and emergency situations.
2. Before using a personal fall arrest system, user must be trained in accordance with the requirements of OSHA 29 CFR 1910.66 in the safe use of the system and its components.
3. Use only with ANSI/OSHA compliant personal fall arrest or restraint systems. The anchorage must have the strength capable of supporting a static load, applied in the directions permitted by the system, of at least 10,000-lbf (44kN) in the absence of certification.
4. The user shall be equipped with a means of limiting the maximum dynamic forces exerted on the user during the arrest of a fall to a maximum of 8 kN (1800-lbf).
5. Use of this product must be approved by an engineer or other qualified person to be compatible with any and all structural & operational characteristics of the selected installation location and system to be connected to this anchorage connector.
6. The anchorage connector must be inspected prior to each use for wear, damage, and other deterioration. If defective components are found the anchorage connector must be immediately removed from service in accordance with the requirements of OSHA 29 CFR 1910.66 and 1926.502.
7. The anchorage connector should be positioned in such a way that minimizes the potential for falls and the potential fall distance during use. The complete fall protection system must be planned (including all components, calculating fall clearance, and swing fall) before using.
8. A rescue plan, and the means at hand to implement it, must be in place that provides the prompt rescue of users in the event of a fall, or assures that users are able to rescue themselves.
9. After a fall occurs the anchorage connector must be removed from service and destroyed immediately.

USE LIMITATIONS: The anchorage connector shall not be used outside its limitations, or for any purpose other than that for which it is intended.

1. The anchorage connector is designed for single user, with a capacity up to 310 lbs (140 kg) including clothing, tools, etc.
2. The anchorage connector may only be loaded in acceptable directions shown in the LOADING CONDITIONS DIAGRAM.
3. The anchorage connector is designed to be used in temperatures ranging from -40°F to +130°F (-40°C to +54°C).
4. Do not expose the anchorage connector to chemicals or harsh solutions which may have a harmful effect.
5. Do not alter or modify this product in any way.
6. Caution must be taken when using any component of a fall protection, work positioning, rope access, or rescue system near moving machinery, electrical hazards, sharp edges, or abrasive surfaces, as contact may cause equipment failure, personal injury, or death.
7. Do not use/install equipment without proper training by a "competent person" as defined by OSHA 29 CFR 1926.32(f).
8. Do not remove the labeling from this product.
9. Additional requirements and limitations may apply depending on anchorage type and fastening option utilized for installation. All placements must be approved by an engineer or other qualified person.
10. This anchorage connector should not be used as part of a horizontal lifeline system that has not been designed and or approved to be used with 10,000-lbf anchorage connectors.
11. The anchorage connector should only be used for personal fall protection and not for lifting equipment.

COMPATIBILITY LIMITATIONS

Anchorage connector must only be coupled to compatible connectors. OSHA 29 CFR 1926.502 prohibits snaphooks from being engaged to certain objects unless two requirements are met: it must be a locking type snaphook, and it must be "designed for" making such a connection. "Designed for" means that the manufacturer of the snaphook specifically designed the snaphook to be used to connect to the equipment listed. The following connections must be avoided, because they can result in rollout* when a nonlocking snaphook is used:

- Direct connection of a snaphook to horizontal lifeline.
- Two (or more) snaphooks connected to one D-ring.
- Two snaphooks connected to each other.
- A snaphook connected back on its integral lanyard.
- A snaphook connected to a webbing loop or webbing lanyard.
- Improper dimensions of the D-ring, rebar, or other connection point in relation to the snaphook dimensions that would allow the snaphook keeper to be depressed by a turning motion of the snaphook.

***Rollout: A process by which a snaphook or carabiner unintentionally disengages from another connector or object to which it is coupled. (ANSI Z359.0-2007)**

10K Swivel Anchor
 Zinc Plated Steel
 Max Capacity:
 (1) person 310-lbs

LABEL LOCATIONS

WARNING: All persons using this equipment must read, understand and follow all instructions. Failure to do so may result in serious injury or death. (INSPECT BEFORE USE)
COMPLIANCE: OSHA 1910.66, OSHA 1926.502, ANSI Z359.1(07), ANSI Z359.7(11), EN 795:1996 Class A (US PAT #8,424,638)

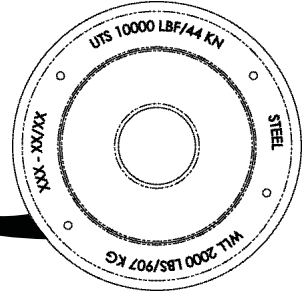

8.0"Ø
(203.2mm)

180°

360°

5.5"
(139.7mm)

2.25"Ø
(57.15mm)

3.0"
(76.2mm)

1.0"
(25.4mm)

Tensile Strength (UTS): 10,000-lbf (44kN)

Working Load: 2,000-lbs (907kg)

Weight: 1.2-lbs (544.3g)

Materials: Zinc Plated Steel

Regulatory Compliance: Meets or exceeds ANSI Z359.1(07), ANSI Z359.7(11), OSHA 1926.502, OSHA 1910.66, EN 795:1996 Class A

LOADING CONDITIONS DIAGRAM

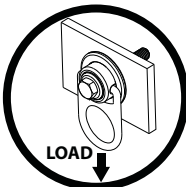

ACCEPTABLE

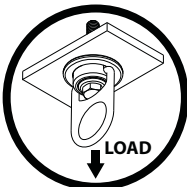

ACCEPTABLE

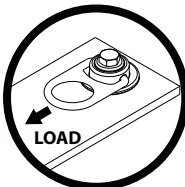

ACCEPTABLE

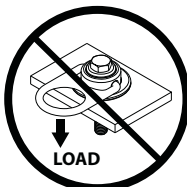

IMPROPER

STEEL MOUNTING

5/8"-11
Lock Nut



5/8" Lock
Washer



5/8"-11x4"
Hex Bolt *

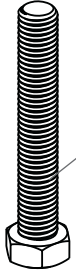

Torque Range:
75-90 ft-lbs
(100-120Nm)

* Use tapered washer with I-beams
that have tapered flanges

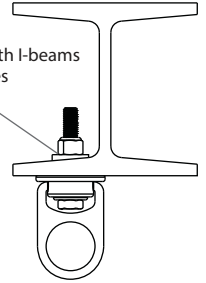

drill 5/8" (16mm)Ø

1/4"
(6mm)
min

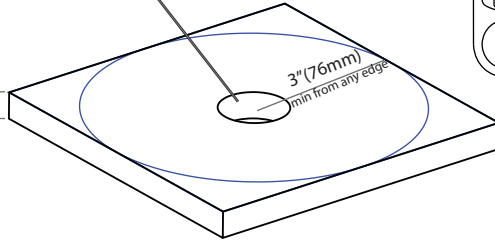

For steel applications a grade-5, 8 (or equivalent) bolt no shorter than 4" (100mm) with a locking nut and washer must be used. Swivel anchor must be flush with steel surface. A 16mm bolt may be used in place of a 5/8"-11 for metric applications.

CONCRETE MOUNTING

- Use a proper drill & bit for concrete (SDS drill bit).
- Drill a 3/4" (19mm) hole no less than 5" (114mm) deep 9" (229mm) away from any edge.
- Hole must be straight & perpendicular to surface.
- Hole must be free of debris.
- Concrete strength must be at least 3000psi (20.7MPa) and no less than 7" (178mm) thick.

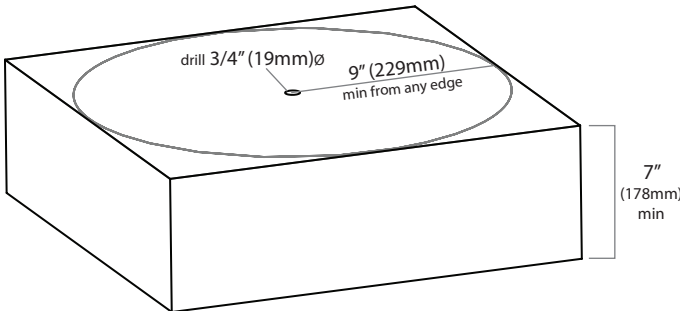

Torque:
110 ft-lbs
(149Nm)

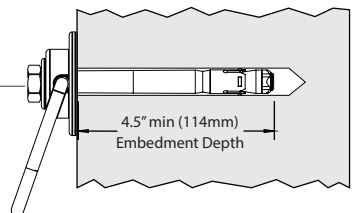

WELD ON MOUNTING

Grade - 5 or 8 bolt
5/8"-11 x 1-3/4"

Torque Range:
75-90 ft-lbs
(100-120Nm)

Internal Tooth Lock Washer

3/8" min
(9.5mm)

* Weld

* Welding procedure must be approved by an engineer or other qualified person to be compatible with any and all structural & operational characteristics of the selected installation location.

BACK PLATE MOUNTING

Back Plate to be used with 5/8" (16mm) bolts or all thread. Drill hole perpendicular into surface so bolt can pass freely through the substrate. Nut must be fully threaded on the bolt to insure maximum strength ratings and integrity of anchor.

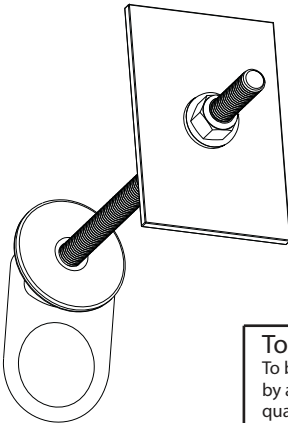

Torque Range:
To be determined
by an engineer or
qualified person.

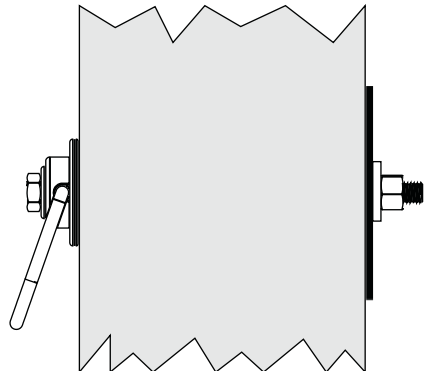

* Bolt or All-thread and nut not included with Back Plate.

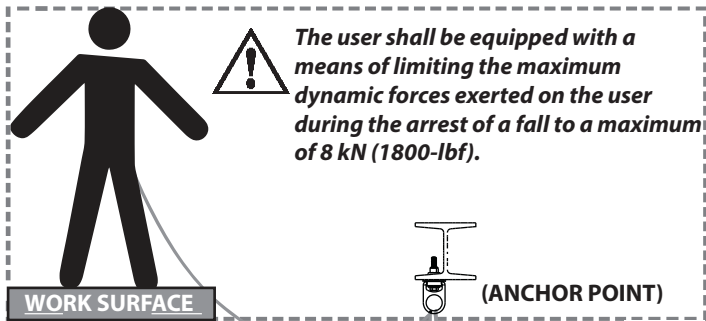

The user shall be equipped with a means of limiting the maximum dynamic forces exerted on the user during the arrest of a fall to a maximum of 8 kN (1800-lbf).



WARNING! *Swing falls may occur when the worker is not directly under anchor point.*

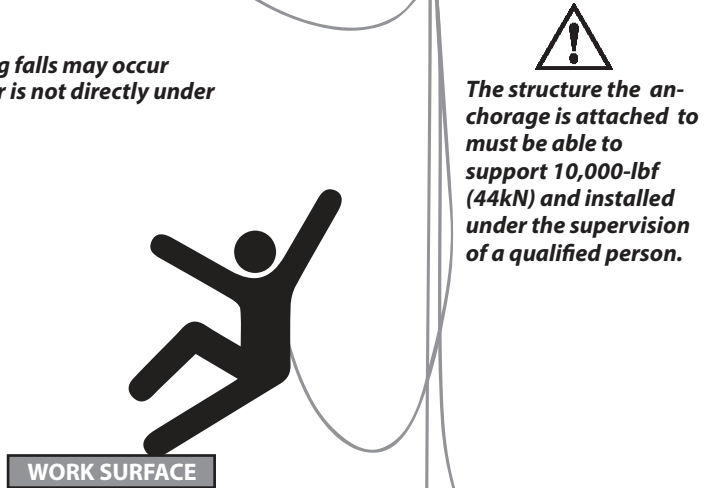

The structure the anchorage is attached to must be able to support 10,000-lbf (44kN) and installed under the supervision of a qualified person.



WARNING! *All products subjected to fall arresting forces should be removed from service immediately!*

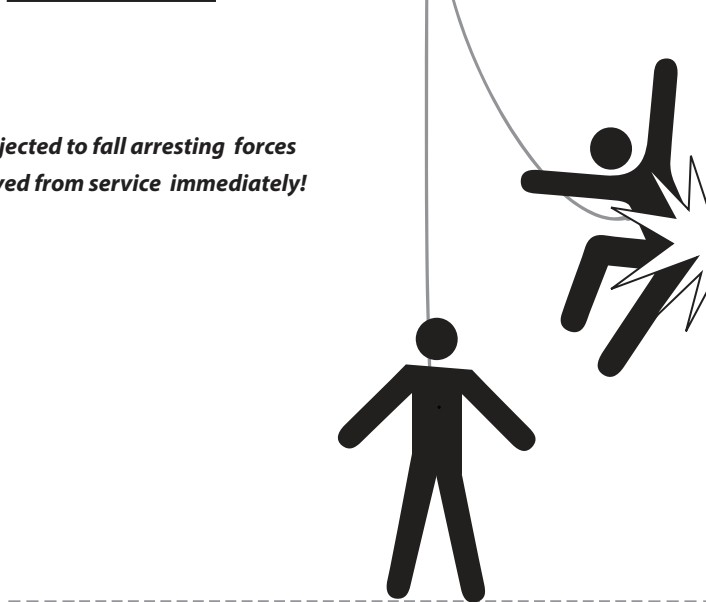

MINIMUM CLEARANCE 3ft (1m)

DECK/FLOOR/GROUND LEVEL

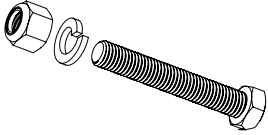
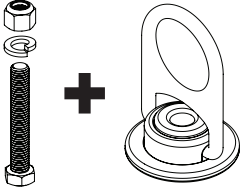
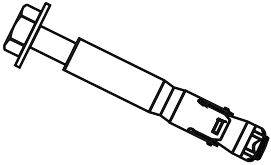
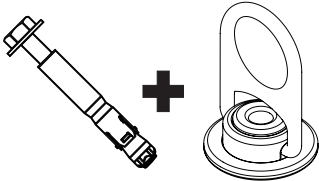
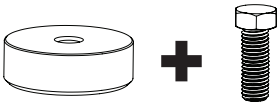
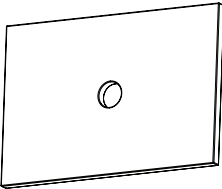
	KIT CONTENTS	PART NUMBER
METAL		HD26250 (Steel Mounting Hardware Kit)
		HD26226 (Swivel with Steel Mounting kit)
CONCRETE		HD26228 (Concrete Hardware Kit)
		HD26227 (Swivel with Concrete Mounting Kit)
ACCESSORIES		HD26252 (Weld-on Mounting Kit)
		HD26240 (Backing Plate Only)

For more information:



MAINTENANCE, CLEANING AND STORAGE

Cleaning periodically will prolong the life and proper functioning of the product. The frequency of cleaning should be determined by inspection and by severity of the environment. Clean with compressed air and/or a stiff brush using plain water or a mild soap and water solution. Do not use any corrosive chemicals that could damage the product. Wipe all surfaces with a clean, dry cloth and hang to dry, or use compressed air. When not in use, store anchorage connectors in a cool, dry, clean environment, out of direct sunlight and free of corrosive or other degrading elements.

INSPECTION AND MAINTENANCE LOG

MODEL NUMBER: _____

DATE OF MANUFACTURE: _____

Date	Part Number	Comments	Inspector Name

Inspection:

Official periodic inspection must be made at least semiannually. The inspection must be performed by a qualified person other than the intended user. If severe weather or conditions exist then inspections must be carried out more frequently. All inspection results must be logged in the space provided above.

1. Inspect Swivel to make sure it is flush with mounting surface.
2. Make sure all labeling is affixed to the unit.
3. Make sure the unit can rotate 360° and D-ring can flip from side to side.
4. When reusing a previously drilled hole, inspect for debris or wallowing.
5. Record inspection results in the space provided above.



If any damage that could affect the strength or operation of the device, or unsafe conditions are found, proper disposal is required. The anchorage connector must be rendered unusable and then properly discarded.

Product Warranty, Limited Remedy and Limitation of Liability

WARRANTY: THE FOLLOWING IS MADE IN LIEU OF ALL WARRANTIES OR CONDITIONS, EXPRESS OR IMPLIED, INCLUDING THE IMPLIED WARRANTIES OR CONDITIONS OF MERCHANTABILITY OR FITNESS FOR A PARTICULAR PURPOSE.

PMI LIMITED WARRANTY

PMI products are warranted to the original retail purchaser to be free from defect in material and workmanship for a period of one year. PMI will repair or replace the item without charge provided inspection at our factory discloses no misuse or alteration, which, in our judgment, has affected the condition or functioning of the product. All implied warranties imposed by law in connection with the sale of PMI products are also limited in duration to a period of one year. PMI expressly excludes and shall not be liable for any consequential damages arising out of any breach of the express or implied warranties on sales of PMI products. Because of the high risks involved in high angle rope work such as, but not limited to, rescue, rope access, caving, rappelling, rock climbing and mountaineering, no further warranties exist or are implied by PMI. Regulations issued under the Magnuson-Moss Warranty Act require us to include the following statement: some states do not allow limitations on how long an implied warranty lasts nor the excluding or limitation of incidental or consequential damages, so the above limitations may not apply to you.

LIMITATION OF LIABILITY: IN NO EVENT WILL PIGEON MOUNTAIN INDUSTRIES BE LIABLE FOR ANY INDIRECT, INCIDENTAL, SPECIAL OR CONSEQUENTIAL DAMAGES INCLUDING, BUT NOT LIMITED TO LOSS OF PROFITS, IN ANY WAY RELATED TO THE PRODUCTS REGARDLESS OF THE LEGAL THEORY ASSERTED.

Pigeon Mountain Industries

PO Box 8031 LaFayette, GA 30728-0803

800-282-ROPE (7673) / www.pmirope.com